

# LM5107

## 100V / 1.4A Peak Half Bridge Gate Driver

### General Description

The LM5107 is a low cost high voltage gate driver, designed to drive both the high side and the low side N-Channel MOSFETs in a synchronous buck or a half bridge configuration. The floating high-side driver is capable of working with rail voltages up to 100V. The outputs are independently controlled with TTL compatible input thresholds. An integrated on chip high voltage diode is provided to charge the high side gate drive bootstrap capacitor. A robust level shifter technology operates at high speed while consuming low power and providing clean level transitions from the control input logic to the high side gate driver. Under-voltage lockout is provided on both the low side and the high side power rails. The device is available in the SOIC-8 and the thermally enhanced LLP-8 packages.

### Features

- Drives both a high side and low side N-Channel MOSFET
- High peak output current (1.4A sink / 1.3A source)
- Independent TTL compatible inputs

- Integrated bootstrap diode
- Bootstrap supply voltage to 118V DC
- Fast propagation times (27 ns typical)
- Drives 1000 pF load with 15ns rise and fall times
- Excellent propagation delay matching (2 ns typical)
- Supply rail under-voltage lockout
- Low power consumption
- Pin compatible with ISL6700

### Typical Applications

- Current Fed push-pull converters
- Half and Full Bridge power converters
- Solid state motor drives
- Two switch forward power converters

### Package

- SOIC-8
- LLP-8 (4 mm x 4 mm)

### Simplified Block Diagram

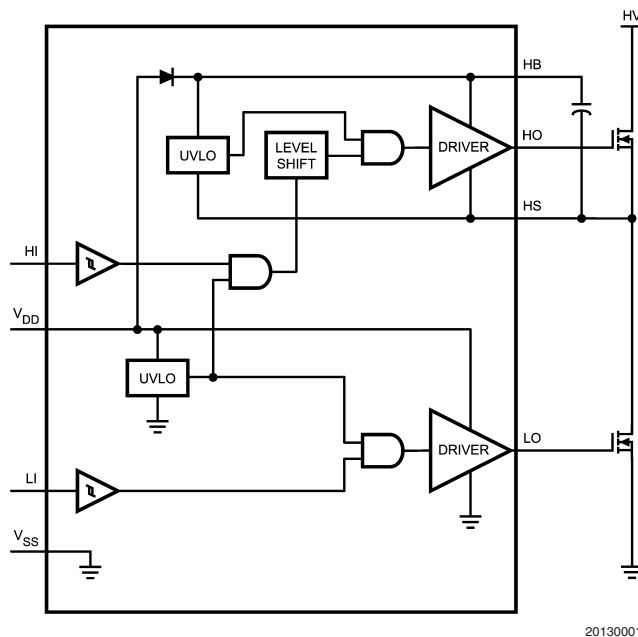

FIGURE 1.

## Connection Diagrams



FIGURE 2.

## Ordering Information

Ordering Number	Package Type	NSC Package Drawing	Supplied As
LM5107MA	SOIC-8	M08A	Shipped in anti static rails
LM5107MAX	SOIC-8	M08A	2500 shipped as Tape & Reel
LM5107SD	LLP-8	SDC08A	1000 shipped as Tape & Reel
LM5107SDX	LLP-8	SDC08A	4500 shipped as Tape & Reel

## Pin Description

Pin #		Name	Description	Application Information
SO-8	LLP-8			
1	1	V <sub>DD</sub>	Positive gate drive supply	Locally decouple to V <sub>SS</sub> using low ESR/ESL capacitor located as close to IC as possible.
2	2	HI	High side control input	The LM5107 HI input is compatible with TTL input thresholds. Unused HI input should be tied to ground and not left open.
3	3	LI	Low side control input	The LM5107 LI input is compatible with TTL input thresholds. Unused LI input should be tied to ground and not left open.
4	4	V <sub>SS</sub>	Ground reference	All signals are referenced to this ground.
5	5	LO	Low side gate driver output	Connect to the gate of the low side N-MOS device.
6	6	HS	High side source connection	Connect to the negative terminal of the bootstrap capacitor and to the source of the high side N-MOS device.
7	7	HO	High side gate driver output	Connect to the gate of the low side N-MOS device.
8	8	HB	High side gate driver positive supply rail	Connect the positive terminal of the bootstrap capacitor to HB and the negative terminal of the bootstrap capacitor to HS. The bootstrap capacitor should be placed as close to IC as possible.

Note: For LLP-8 package it is recommended that the exposed pad on the bottom of the LM5107 be soldered to ground plane on the PCB board and the ground plane should extend out from underneath the package to improve heat dissipation.

**Absolute Maximum Ratings** (Note 1)

If Military/Aerospace specified devices are required, please contact the National Semiconductor Sales Office/Distributors for availability and specifications.

$V_{DD}$ to $V_{SS}$	-0.3V to 18V
HB to HS	-0.3V to 18V
LI or HI to $V_{SS}$	-0.3V to $V_{DD} + 0.3V$
LO to $V_{SS}$	-0.3V to $V_{DD} + 0.3V$
HO to $V_{SS}$	$V_{HS} - 0.3V$ to $V_{HB} + 0.3V$
HS to $V_{SS}$ (Note 6)	-5V to 100V
HB to $V_{SS}$	118V
Junction Temperature	-40°C to +150°C

Storage Temperature Range -55°C to +150°C

ESD Rating HBM (Note 2) 2 kV

**Recommended Operating Conditions**

$V_{DD}$	8V to 14V
HS (Note 6)	-1V to 100V
HB	$V_{HS} + 8V$ to $V_{HS} + 14V$
HS Slew Rate	< 50 V/ns
Junction Temperature	-40°C to +125°C

**Electrical Characteristics**

Specifications in standard typeface are for  $T_J = +25^\circ\text{C}$ , and those in **boldface type** apply over the full **operating junction temperature range**. Unless otherwise specified,  $V_{DD} = V_{HB} = 12V$ ,  $V_{SS} = V_{HS} = 0V$ , No Load on LO or HO.

Symbol	Parameter	Conditions	Min	Typ	Max	Units
<b>SUPPLY CURRENTS</b>						
$I_{DD}$	$V_{DD}$ Quiescent Current	LI = HI = 0V		0.3	<b>0.6</b>	mA
$I_{DDO}$	$V_{DD}$ Operating Current	f = 500 kHz		2.1	<b>3.4</b>	mA
$I_{HB}$	Total HB Quiescent Current	LI = HI = 0V		0.06	<b>0.2</b>	mA
$I_{HBO}$	Total HB Operating Current	f = 500 kHz		1.6	<b>3.0</b>	mA
$I_{HBS}$	HB to $V_{SS}$ Current, Quiescent	$V_{HS} = V_{HB} = 100V$		0.1	<b>10</b>	$\mu\text{A}$
$I_{HBSO}$	HB to $V_{SS}$ Current, Operating	f = 500 kHz		0.5		mA
<b>INPUT PINS LI and HI</b>						
$V_{IL}$	Low Level Input Voltage Threshold		<b>0.8</b>	1.8		V
$V_{IH}$	High Level Input Voltage Threshold			1.8	<b>2.2</b>	V
$R_I$	Input Pulldown Resistance		<b>100</b>	180	<b>500</b>	k $\Omega$
<b>UNDER VOLTAGE PROTECTION</b>						
$V_{DDR}$	$V_{DD}$ Rising Threshold	$V_{DDR} = V_{DD} - V_{SS}$	<b>6.0</b>	6.9	<b>7.4</b>	V
$V_{DDH}$	$V_{DD}$ Threshold Hysteresis			0.5		V
$V_{HBR}$	HB Rising Threshold	$V_{HBR} = V_{HB} - V_{HS}$	<b>5.7</b>	6.6	<b>7.1</b>	V
$V_{HBH}$	HB Threshold Hysteresis			0.4		V
<b>BOOT STRAP DIODE</b>						
$V_{DL}$	Low-Current Forward Voltage	$I_{VDD-HB} = 100 \mu\text{A}$ $V_{DL} = V_{DD} - V_{HB}$		0.58	<b>0.9</b>	V
$V_{DH}$	High-Current Forward Voltage	$I_{VDD-HB} = 100 \text{mA}$ $V_{DH} = V_{DD} - V_{HB}$		0.82	<b>1.1</b>	V
$R_D$	Dynamic Resistance	$I_{VDD-HB} = 100 \text{mA}$		0.8	<b>1.5</b>	$\Omega$
<b>LO GATE DRIVER</b>						
$V_{OLL}$	Low-Level Output Voltage	$I_{LO} = 100 \text{mA}$ $V_{OHL} = V_{LO} - V_{SS}$		0.28	<b>0.45</b>	V
$V_{OHL}$	High-Level Output Voltage	$I_{LO} = -100 \text{mA}$ , $V_{OHL} = V_{DD} - V_{LO}$		0.45	<b>0.75</b>	V
$I_{OHL}$	Peak Pullup Current	$V_{LO} = 0V$		1.3		A
$I_{OLL}$	Peak Pulldown Current	$V_{LO} = 12V$		1.4		A
<b>HO GATE DRIVER</b>						
$V_{OLH}$	Low-Level Output Voltage	$I_{HO} = 100 \text{mA}$ $V_{OLH} = V_{HO} - V_{HS}$		0.28	<b>0.45</b>	V
$V_{OHH}$	High-Level Output Voltage	$I_{HO} = -100 \text{mA}$ $V_{OHH} = V_{HB} - V_{HO}$		0.45	<b>0.75</b>	V
$I_{OHH}$	Peak Pullup Current	$V_{HO} = 0V$		1.3		A
$I_{OLH}$	Peak Pulldown Current	$V_{HO} = 12V$		1.4		A

## Electrical Characteristics (Continued)

Specifications in standard typeface are for  $T_J = +25^\circ\text{C}$ , and those in **boldface type** apply over the full **operating junction temperature range**. Unless otherwise specified,  $V_{DD} = V_{HB} = 12\text{V}$ ,  $V_{SS} = V_{HS} = 0\text{V}$ , No Load on LO or HO.

Symbol	Parameter	Conditions	Min	Typ	Max	Units
<b>HO GATE DRIVER</b>						
<b>THERMAL RESISTANCE</b>						
$\theta_{JA}$	Junction to Ambient	SOIC-8		160		°C/W
		LLP-8 (Note 3)		40		

## Switching Characteristics

Specifications in standard typeface are for  $T_J = +25^\circ\text{C}$ , and those in **boldface type** apply over the full **operating junction temperature range**. Unless otherwise specified,  $V_{DD} = V_{HB} = 12\text{V}$ ,  $V_{SS} = V_{HS} = 0\text{V}$ , No Load on LO or HO.

Symbol	Parameter	Conditions	Min	Typ	Max	Units
<b>LM5100A</b>						
$t_{LPHL}$	Lower Turn-Off Propagation Delay (LI Falling to LO Falling)			27	<b>56</b>	ns
$t_{HPHL}$	Upper Turn-Off Propagation Delay (HI Falling to HO Falling)			27	<b>56</b>	ns
$t_{LPLH}$	Lower Turn-On Propagation Delay (LI Rising to LO Rising)			29	<b>56</b>	ns
$t_{HPLH}$	Upper Turn-On Propagation Delay (HI Rising to HO Rising)			29	<b>56</b>	ns
$t_{MON}$	Delay Matching: Lower Turn-On and Upper Turn-Off			2	<b>15</b>	ns
$t_{MOFF}$	Delay Matching: Lower Turn-Off and Upper Turn-On			2	<b>15</b>	ns
$t_{RC}, t_{FC}$	Either Output Rise/Fall Time	$C_L = 1000\text{ pF}$		15	-	ns
$t_{PW}$	Minimum Input Pulse Width that Changes the Output			50		ns
$t_{BS}$	Bootstrap Diode Turn-Off Time	$I_F = 100\text{ mA}$ , $I_R = 100\text{ mA}$		105		ns

**Note 1:** Absolute Maximum Ratings indicate limits beyond which damage to the component may occur. Operating Ratings are conditions under which operation of the device is guaranteed. Operating Ratings do not imply guaranteed performance limits. For guaranteed performance limits and associated test conditions, see the Electrical Characteristics tables.

**Note 2:** The human body model is a 100 pF capacitor discharged through a 1.5k $\Omega$  resistor into each pin. Pin 6, Pin 7 and Pin 8 are rated at 500V.

**Note 3:** 4 layer board with Cu finished thickness 1.5/1/1.5 oz. Maximum die size used. 5x body length of Cu trace on PCB top. 50 x 50mm ground and power planes embedded in PCB. See Application Note AN-1187.

**Note 4:** Min and Max limits are 100% production tested at 25°C. Limits over the operating temperature range are guaranteed through correlation using Statistical Quality Control (SQC) methods. Limits are used to calculate National's Average Outgoing Quality Level (AOQL).

**Note 5:** The  $\theta_{JA}$  is not a constant for the package and depends on the printed circuit board design and the operating conditions.

**Note 6:** In the application the HS node is clamped by the body diode of the external lower N-MOSFET, therefore the HS voltage will generally not exceed -1V. However in some applications, board resistance and inductance may result in the HS node exceeding this stated voltage transiently.

If negative transients occur on HS, the HS voltage must never be more negative than  $V_{DD} - 15\text{V}$ . For example, if  $V_{DD} = 10\text{V}$ , the negative transients at HS must not exceed -5V.

# Typical performance Characteristics

**V<sub>DD</sub> Operating Current vs Frequency**

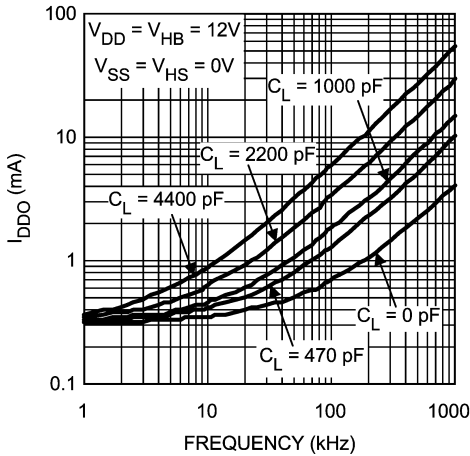

20130004

**HB Operating Current vs Frequency**

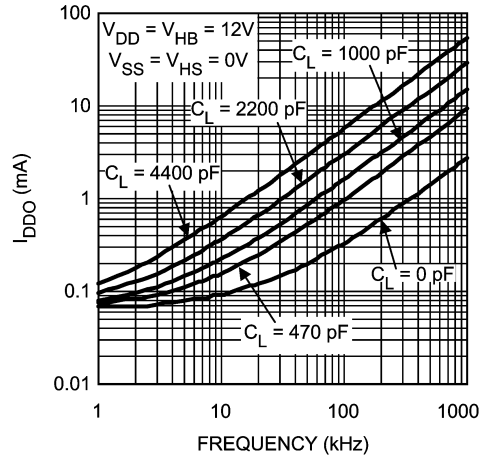

20130005

**Operating Current vs Temperature**

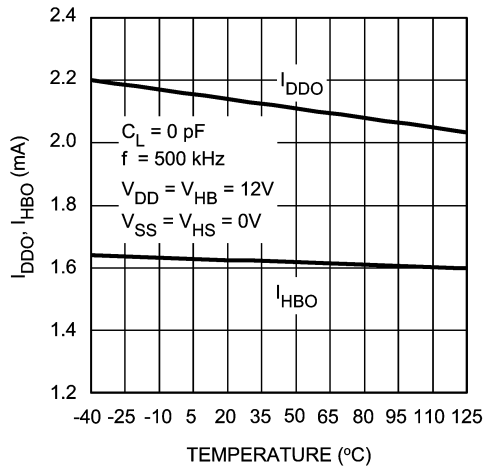

20130006

**Quiescent Current vs Temperature**

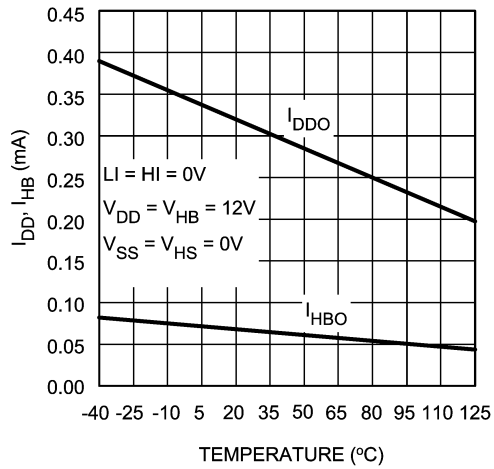

20130007

**Quiescent Current vs Voltage**

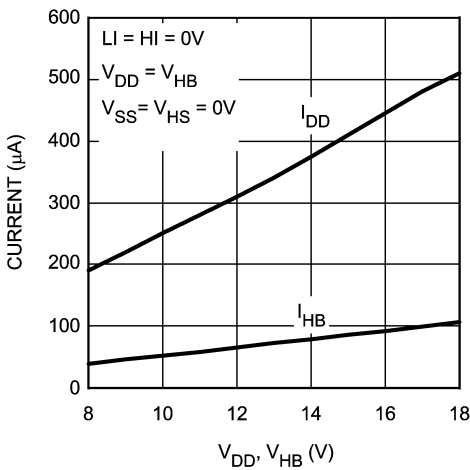

20130008

**Propagation Delay vs Temperature**

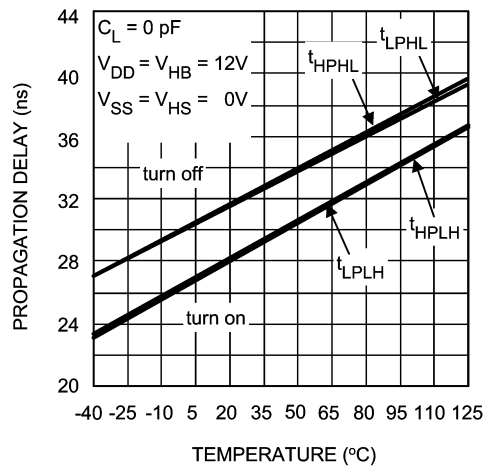

20130009

# Typical performance Characteristics (Continued)

LO and HO High Level Output Voltage vs Temperature

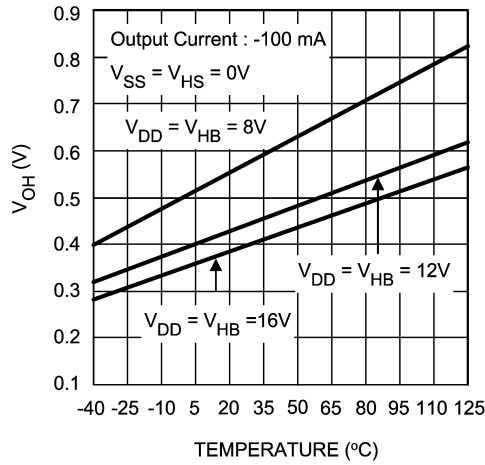

20130010

LO and HO Low Level Output Voltage vs Temperature

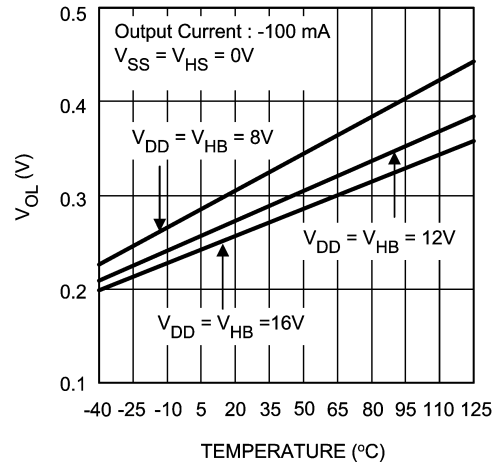

20130011

HO and LO Peak Output Current vs Output Voltage

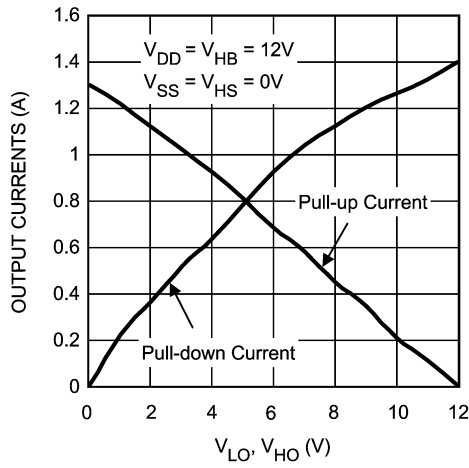

20130012

Diode Forward Voltage

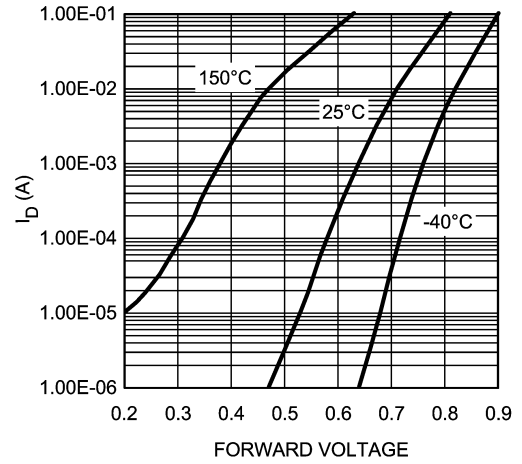

20130013

Undervoltage Rising Thresholds vs Temperature

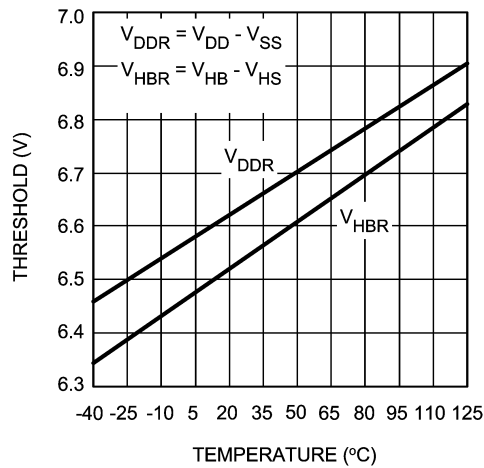

20130014

Undervoltage Hysteresis vs Temperature

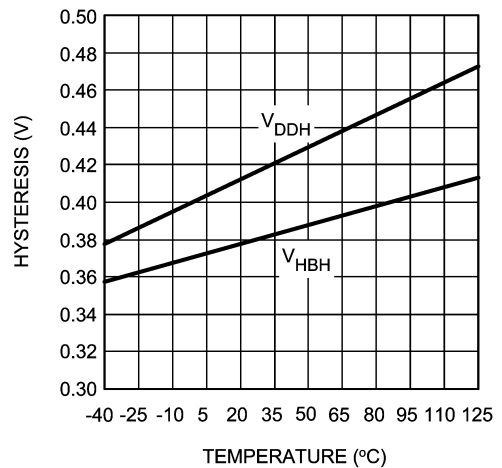

20130015

# Typical performance Characteristics (Continued)

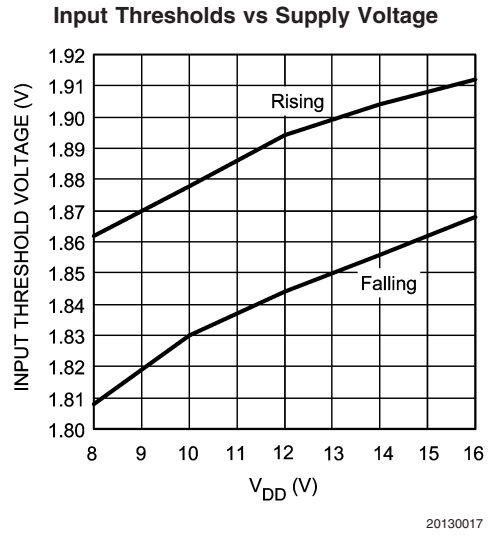
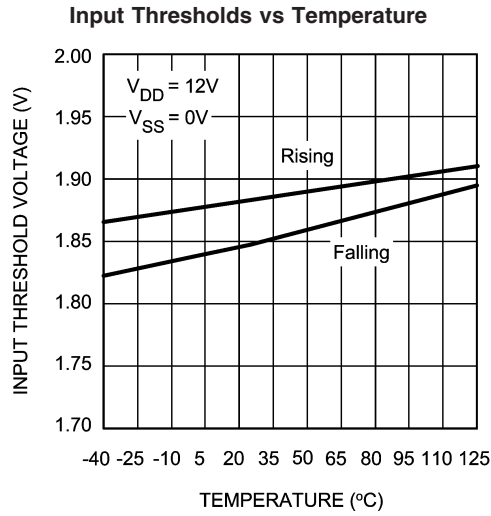

## Timing Diagram

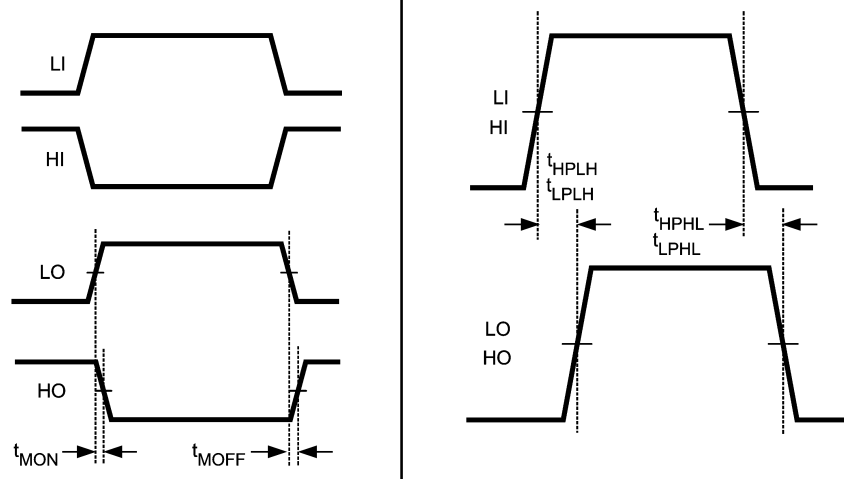

20130018

FIGURE 3.

## Layout Considerations

The optimum performance of high and low side gate drivers cannot be achieved without taking due considerations during circuit board layout. Following points are emphasized.

1. A low ESR / ESL capacitor must be connected close to the IC, and between  $V_{DD}$  and  $V_{SS}$  pins and between HB and HS pins to support high peak currents being drawn from VDD during turn-on of the external MOSFET.
2. To prevent large voltage transients at the drain of the top MOSFET, a low ESR electrolytic capacitor must be connected between MOSFET drain and ground ( $V_{SS}$ ).
3. In order to avoid large negative transients on the switch node (HS) pin, the parasitic inductances in the source of top MOSFET and in the drain of the bottom MOSFET (synchronous rectifier) must be minimized.
4. Grounding Considerations:
  - a) The first priority in designing grounding connections is to confine the high peak currents from charging and discharging the MOSFET gate in a minimal physical area. This will decrease the loop inductance and minimize noise issues on the gate terminal of the MOSFET. The MOSFETs should be placed as close as possible to the gate driver.
  - b) The second high current path includes the bootstrap capacitor, the bootstrap diode, the local ground referenced bypass capacitor and low side MOSFET body diode. The bootstrap capacitor is recharged on the cycle-by-cycle basis through the bootstrap diode from the ground referenced  $V_{DD}$  bypass capacitor. The recharging occurs in a short time interval and involves high

peak current. Minimizing this loop length and area on the circuit board is important to ensure reliable operation.

## HS Transient Voltages Below Ground

The HS node will always be clamped by the body diode of the lower external FET. In some situations, board resistances and inductances can cause the HS node to transiently swing several volts below ground. The HS node can swing below ground provided:

1. HS must always be at a lower potential than HO. Pulling HO more than  $-0.3V$  below HS can activate parasitic transistors resulting in excessive current to flow from the HB supply possibly resulting in damage to the IC. The same relationship is true with LO and VSS. If necessary, a Schottky diode can be placed externally between HO and HS or LO and GND to protect the IC from this type of transient. The diode must be placed as close to the IC pins as possible in order to be effective.
2. HB to HS operating voltage should be 15V or less. Hence, if the HS pin transient voltage is  $-5V$ , VDD should be ideally limited to 10V to keep HB to HS below 15V.
3. A low ESR bypass capacitor between HB to HS as well as VDD to VSS is essential for proper operation. The capacitor should be located at the leads of the IC to minimize series inductance. The peak currents from LO and HO can be quite large. Any series inductances with the bypass capacitor will cause voltage ringing at the leads of the IC which must be avoided for reliable operation.



**Physical Dimensions** inches (millimeters) unless otherwise noted

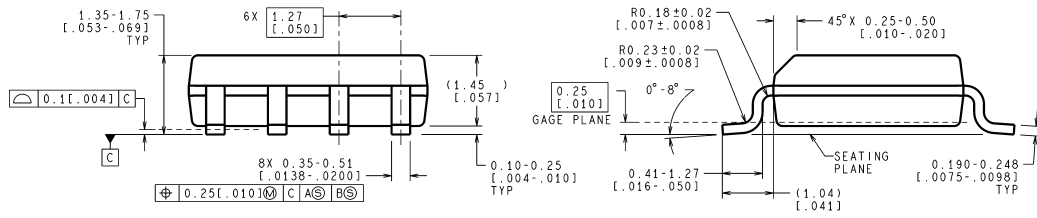
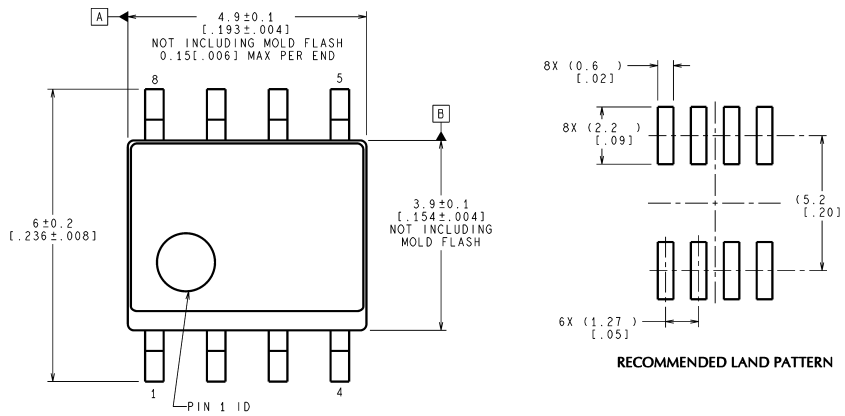

CONTROLLING DIMENSION IS MILLIMETER  
 VALUES IN [ ] ARE INCHES  
 DIMENSIONS IN ( ) FOR REFERENCE ONLY

M08A (Rev K)

Controlling dimension is inch. Values in [ ] are millimeters.

Notes: Unless otherwise specified.

1. Standard lead finish to be 200 microinches/5.08 micrometers minimum lead/tin (solder) on copper.
2. Dimension does not include mold flash.
3. Reference JEDEC registration MS-012, Variation AA, dated May 1990.

**SOIC-8 Outline Drawing  
 NS Package Number M08A**

**Physical Dimensions** inches (millimeters) unless otherwise noted (Continued)

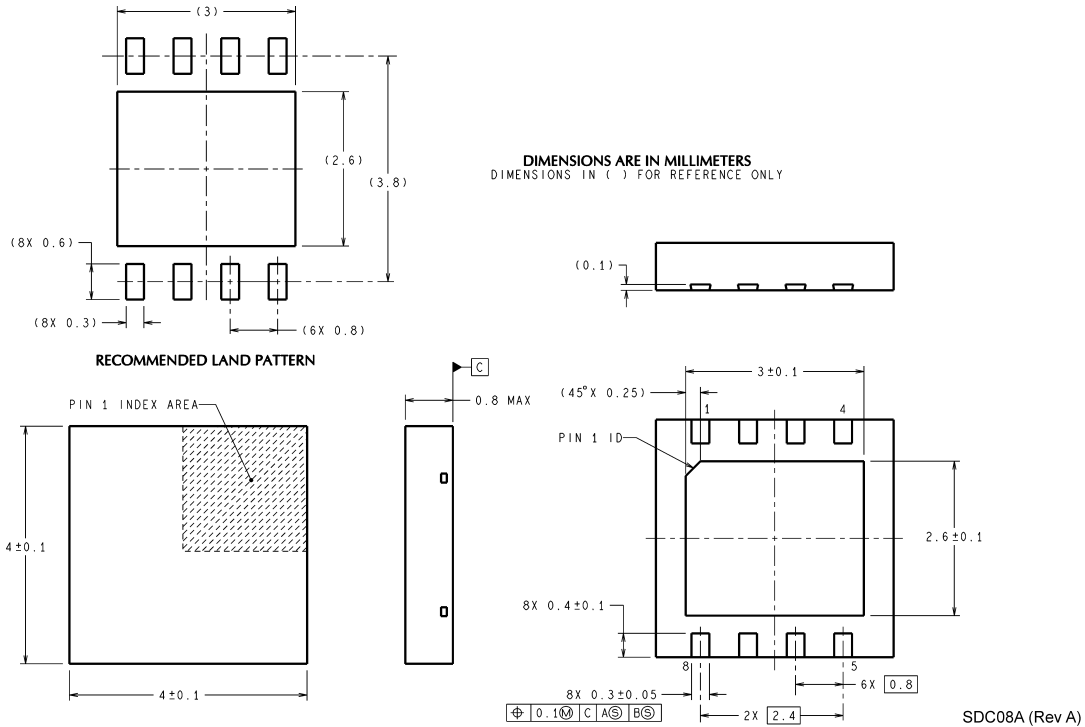

Notes: Unless otherwise specified.

1. For solder thickness and composition, see "Solder Information" in the packaging section of the National Semiconductor web page ([www.national.com](http://www.national.com)).
2. Maximum allowable metal burr on lead tips at the package edges is 76 microns.
3. No JEDEC registration as of May 2003.

**LLP-8 Outline Drawing  
NS Package Number SDC08A**

National does not assume any responsibility for use of any circuitry described, no circuit patent licenses are implied and National reserves the right at any time without notice to change said circuitry and specifications.

For the most current product information visit us at [www.national.com](http://www.national.com).

**LIFE SUPPORT POLICY**

NATIONAL'S PRODUCTS ARE NOT AUTHORIZED FOR USE AS CRITICAL COMPONENTS IN LIFE SUPPORT DEVICES OR SYSTEMS WITHOUT THE EXPRESS WRITTEN APPROVAL OF THE PRESIDENT AND GENERAL COUNSEL OF NATIONAL SEMICONDUCTOR CORPORATION. As used herein:

1. Life support devices or systems are devices or systems which, (a) are intended for surgical implant into the body, or (b) support or sustain life, and whose failure to perform when properly used in accordance with instructions for use provided in the labeling, can be reasonably expected to result in a significant injury to the user.
2. A critical component is any component of a life support device or system whose failure to perform can be reasonably expected to cause the failure of the life support device or system, or to affect its safety or effectiveness.

**BANNED SUBSTANCE COMPLIANCE**

National Semiconductor manufactures products and uses packing materials that meet the provisions of the Customer Products Stewardship Specification (CSP-9-111C2) and the Banned Substances and Materials of Interest Specification (CSP-9-111S2) and contain no "Banned Substances" as defined in CSP-9-111S2.

 **National Semiconductor**  
Americas Customer  
Support Center  
Email: [new.feedback@nsc.com](mailto:new.feedback@nsc.com)  
Tel: 1-800-272-9959

**National Semiconductor**  
Europe Customer Support Center  
Fax: +49 (0) 180-530 85 86  
Email: [europe.support@nsc.com](mailto:europe.support@nsc.com)  
Deutsch Tel: +49 (0) 69 9508 6208  
English Tel: +44 (0) 870 24 0 2171  
Français Tel: +33 (0) 1 41 91 8790

**National Semiconductor**  
Asia Pacific Customer  
Support Center  
Email: [ap.support@nsc.com](mailto:ap.support@nsc.com)

**National Semiconductor**  
Japan Customer Support Center  
Fax: 81-3-5639-7507  
Email: [jpn.feedback@nsc.com](mailto:jpn.feedback@nsc.com)  
Tel: 81-3-5639-7560